

- ◆ MATERIAL:PMMA(壓克力)
- ◆ COLOR:CLEAR
- ◆ UNIT:mm

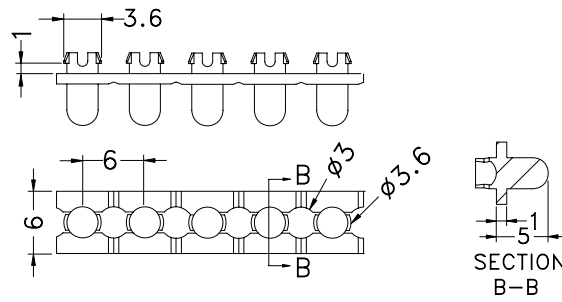

PART NO	PACKAGE
LEM-24	250

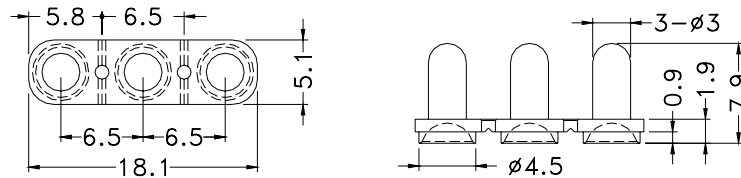

PART NO	PACKAGE
LEM-11	1000

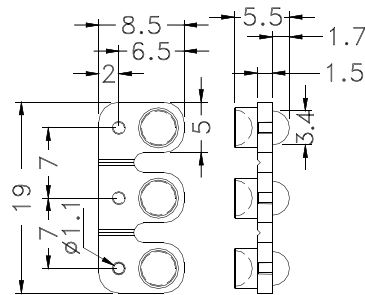

PART NO	PACKAGE
LEM-18	1000

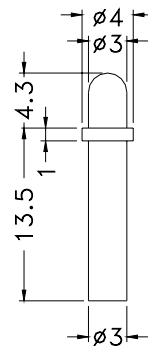

PART NO	PACKAGE
LEM-5	1000

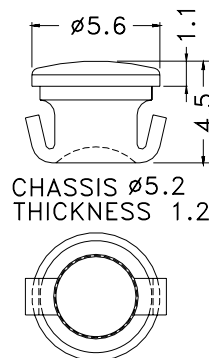

PART NO	PACKAGE
LEM-7	1000

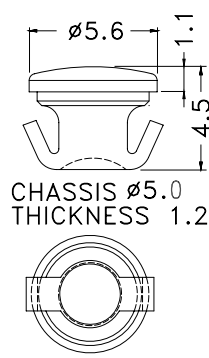

PART NO	PACKAGE
LEM-7S	1000

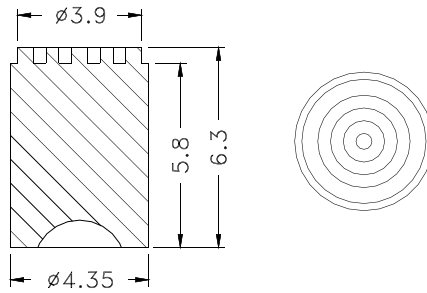
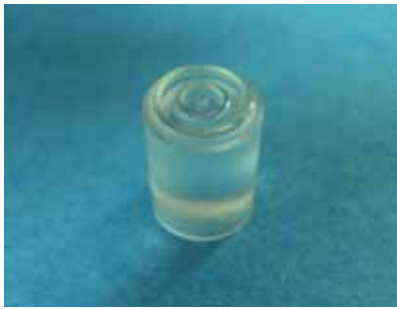

- ◆ MATERIAL:PC(UL)
- ◆ FLAME CLASS:94V-2
- ◆ COLOR:NATURAL
- ◆ UNIT:mm

PART NO	PACKAGE
LEM-20	1000

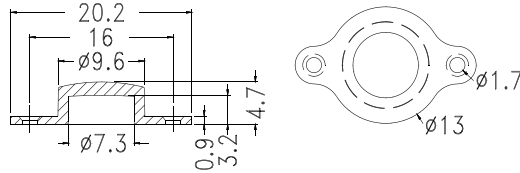

PART NO	PACKAGE
IRCV-1	1000

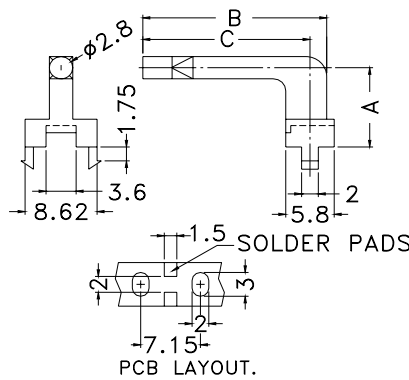

PART NO	A	B	C	PACKAGE
LPE1-5-16	5.0	16.0	14.0	500
LPE1-5-19		19.0	17.0	
LPE1-5-22		22.0	20.0	
LPE1-10-16	10.0	16.0	14.0	
LPE1-10-19		19.0	17.0	
LPE1-10-22		22.0	20.0	
★LPE1-10-26		27.0	25.0	
LPE1-15-16	15.0	16.0	14.0	
LPE1-15-19		19.0	17.0	
LPE1-15-22		22.0	20.0	

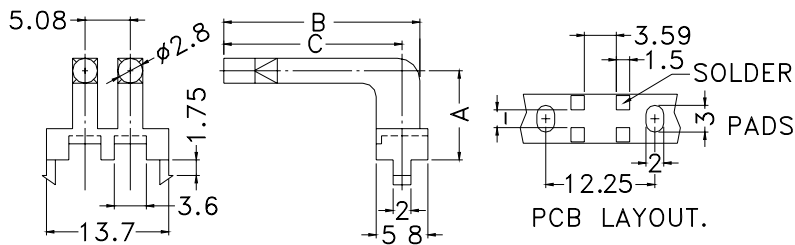

PART NO	A	B	C	PACKAGE
LPE2-5-16	5.0	16.0	14.0	250
LPE2-5-19		19.0	17.0	
LPE2-5-22		22.0	20.0	
LPE2-10-16	10.0	16.0	14.0	
LPE2-10-19		19.0	17.0	
LPE2-10-22		22.0	20.0	
LPE2-15-16	15.0	16.0	14.0	
LPE2-15-19		19.0	17.0	
LPE2-15-22		22.0	20.0	

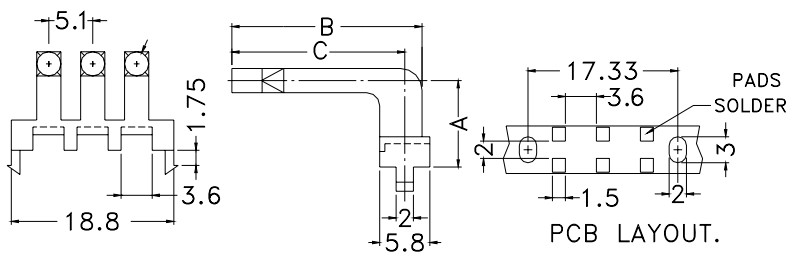

PART NO	A	B	C	PACKAGE
LPE3-5-16	5.0	16.0	14.0	100
LPE3-5-19		19.0	17.0	
LPE3-5-22		22.0	20.0	
LPE3-10-16	10.0	16.0	14.0	
LPE3-10-19		19.0	17.0	
LPE3-10-22		22.0	20.0	
LPE3-15-16	15.0	16.0	14.0	
LPE3-15-19		19.0	17.0	
LPE3-15-22		22.0	20.0	

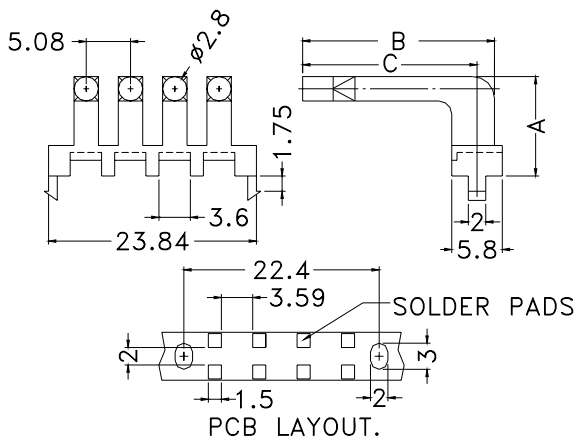

PART NO	A	B	C	PACKAGE
LPE4-5-16	5.0	16.0	14.0	100
LPE4-5-19		19.0	17.0	
LPE4-5-22		22.0	20.0	
LPE4-10-16	10.0	16.0	14.0	
LPE4-10-19		19.0	17.0	
LPE4-10-22		22.0	20.0	
LPE4-15-16	15.0	16.0	14.0	
LPE4-15-19		19.0	17.0	
LPE4-15-22		22.0	20.0	

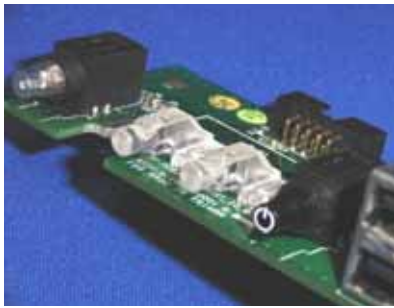

- ◆ MATERIAL:PC(UL)
- ◆ FLAME CLASS :94V-0
- ◆ COLOR:CLEAR
- ◆ UNIT:mm

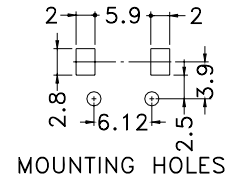
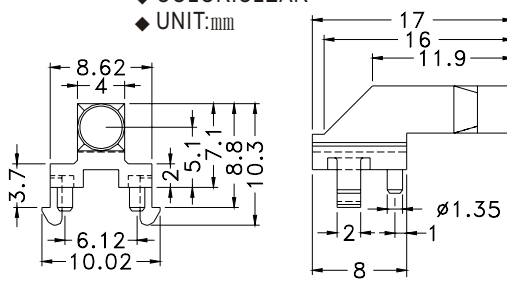

MOUNTING HOLES

PART NO	PACKAGE
LPF1-517	2000

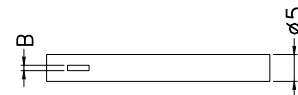
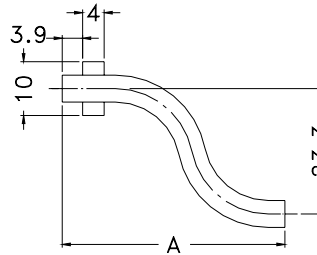

PART NO	A	B	PACKAGE
LPG-1	41.5	1.3	250
LPG-2	76.5	1.2	100

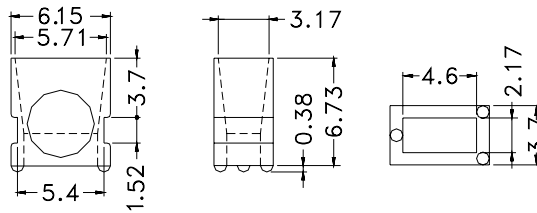
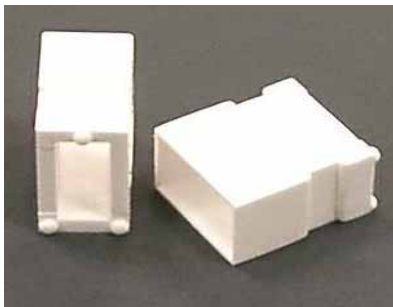

PART NO	PACKAGE
ELED-1	2000

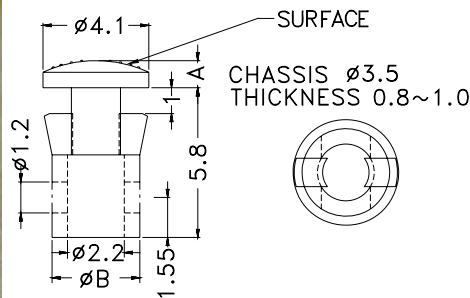

PART NO	A	B	SURFACE	PACKAGE
LEU-1	1.1	3.4	Ring	2000
★ LEU-2	1.05	3.35	Fog	

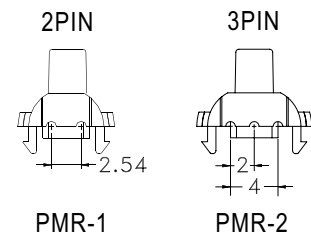
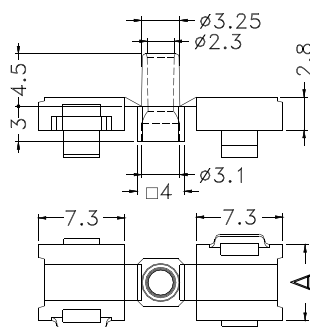

PART NO	A	PACKAGE
PMR-1	6.4	2000
★ PMR-2	7.86	

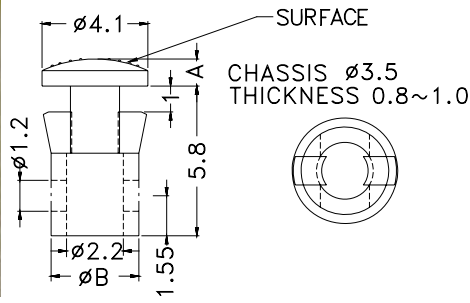

PART NO	A	B	SURFACE	PACKAGE
LEU-1	1.1	3.4	Ring	2000
★LEU-2	1.05	3.35	Fog	

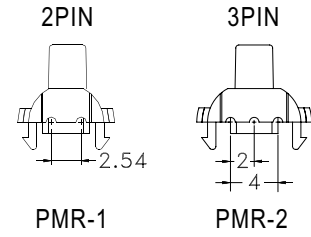
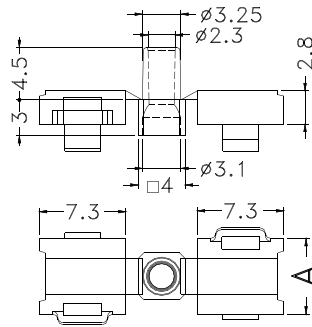

PART NO	A	PACKAGE
PMR-1	6.4	2000
★PMR-2	7.86	