

# FLAT CABLE MOUNT / CLAMP

Hankook Fastener

- ◆ MATERIAL: NYLON 66(UL)
- ◆ FLAME CLASS :94V-2
- ◆ COLOR:NATURAL
- ◆ UNIT:mm

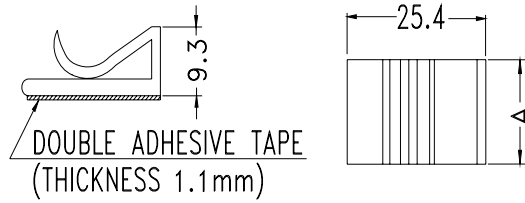
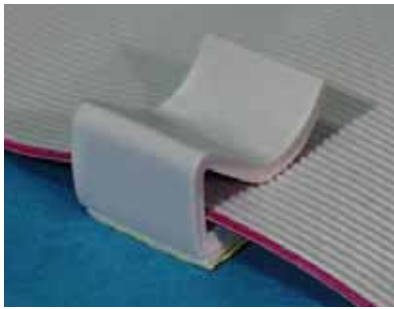

PART NO	A	PACKAGE
FCC-15	15.0	500
FCC-20	20.0	
FCC-25	25.0	250

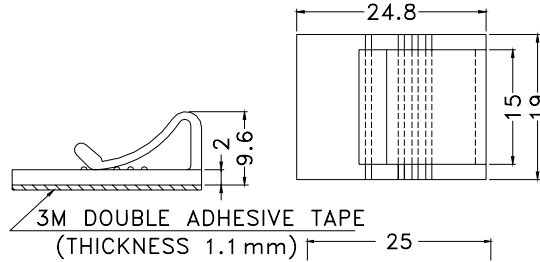
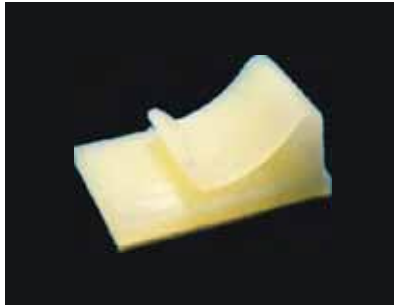

PART NO	PACKAGE
FC-19	500

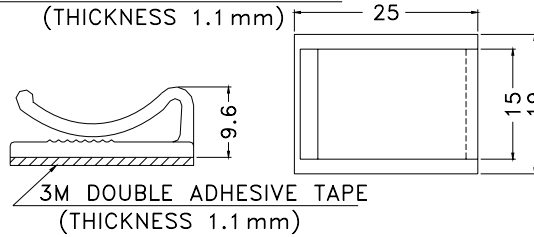

PART NO	PACKAGE
FC-19L	500

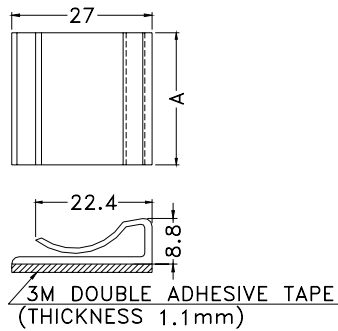
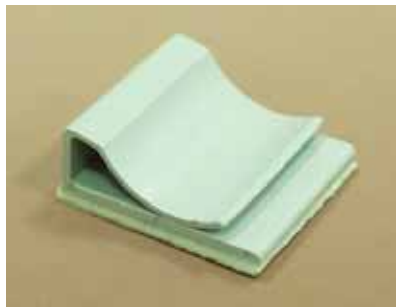

PART NO	A	PACKAGE
FCN-15	15.0	500
FCN-20	20.0	
FCN-25	25.4	

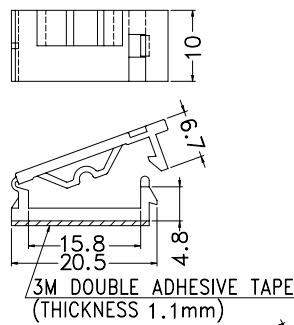
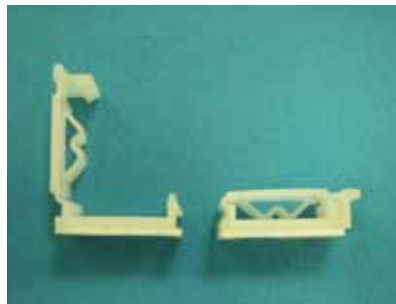

PART NO	PACKAGE
FCS-15	500

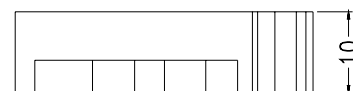
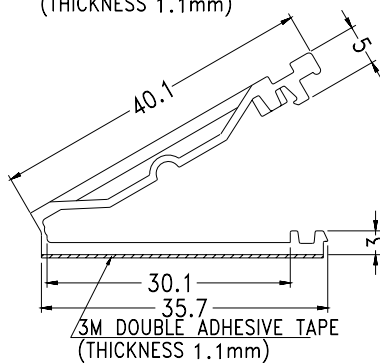

PART NO	PACKAGE
FCS-20	200

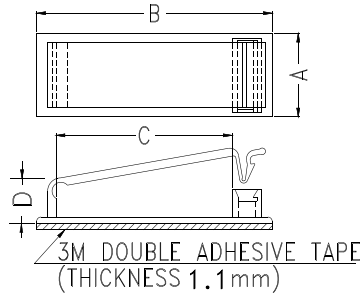
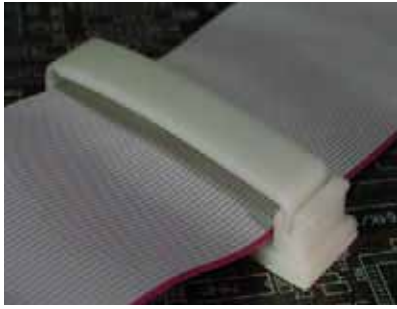

- ◆ MATERIAL: NYLON 66(UL)
- ◆ FLAME CLASS :94V-2
- ◆ COLOR:NATURAL
- ◆ UNIT:mm

PART NO	A	B	C	D	PACKAGE
FCA-1	19.7	77.6	64.0	12.8	50
FCA-2	19.0	53.5	40.0	11.2	100
FCA-3		45.8	32.0		200
FCA-5	19.8	45.4	31.8	18.0	

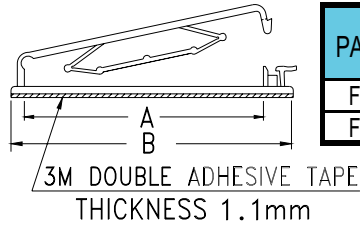

PART NO	A	B	C	SUITABLE CABLE	PACKAGE
FCB-40	53.8	65.0	10.2	40 PIN	200
FCB-50	64.5	77.0	10.0	50 PIN	100

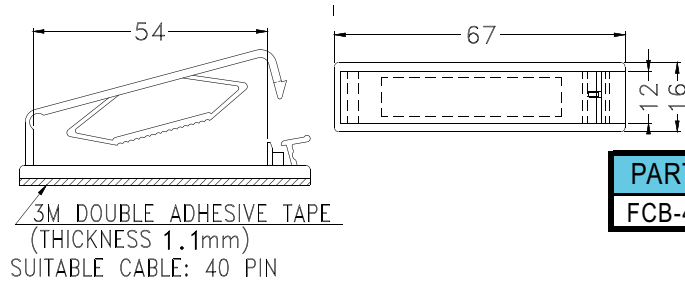

PART NO	PACKAGE
FCB-40MT	100

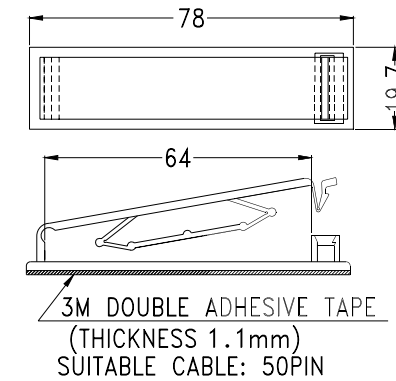

PART NO	PACKAGE
FCB-1	100

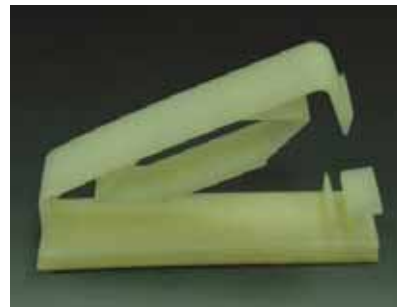

PART NO	PACKAGE
FCB-40M	100

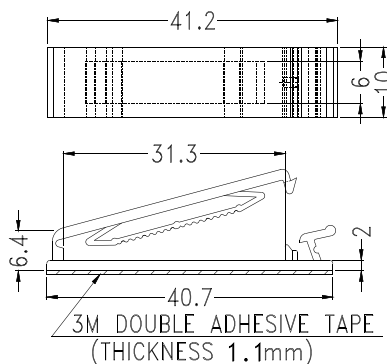
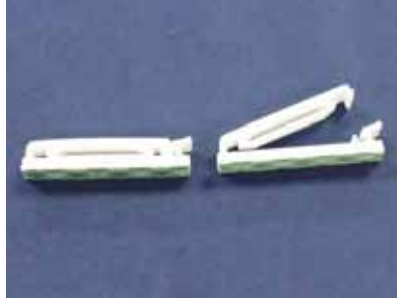
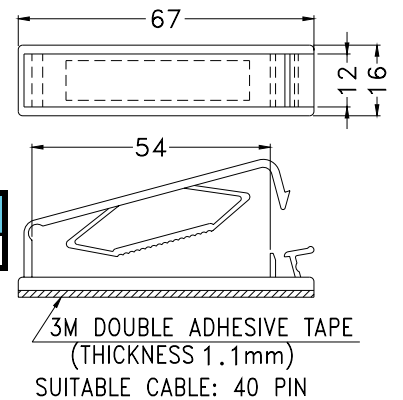

PART NO	PACKAGE
FCI-1	200

# FLAT CABLE MOUNT / CLAMP

Hankook Fastener

- ◆ MATERIAL: NYLON 66(UL)
- ◆ FLAME CLASS : 94V-2
- ◆ COLOR: NATURAL
- ◆ UNIT: mm

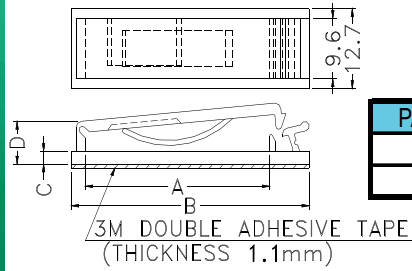

PART NO	A	B	C	D	PACKAGE
FCE-1	31.5	40.7	2.0	6.8	200
FCE-2	52.0	61.2	2.1	6.9	100

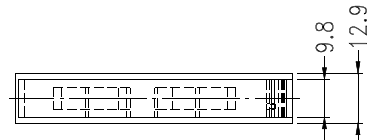
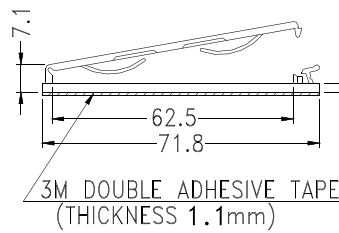

PART NO	PACKAGE
FCE-3	100

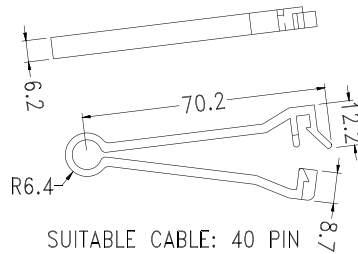

PART NO	PACKAGE
FCE-40	100

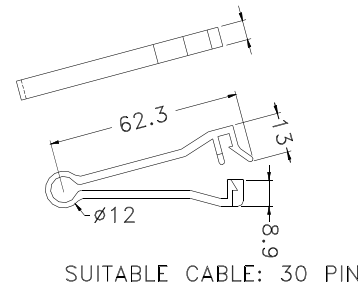

PART NO	PACKAGE
FCE-30	100

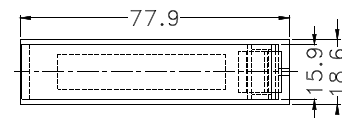
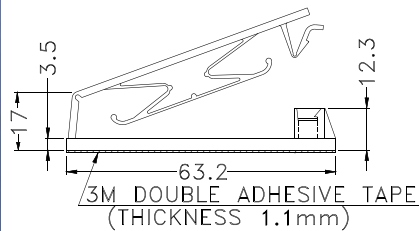

PART NO	PACKAGE
FCK-50	100

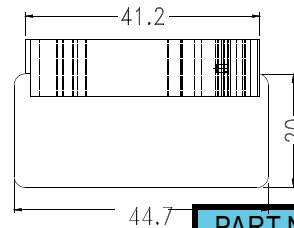
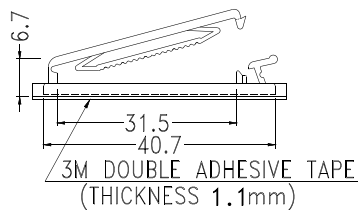
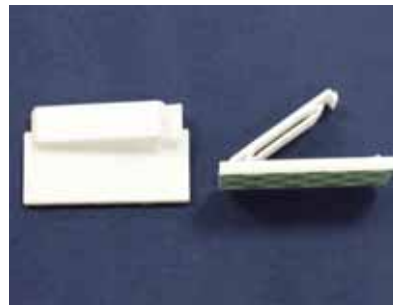

PART NO	PACKAGE
FCI-2	100

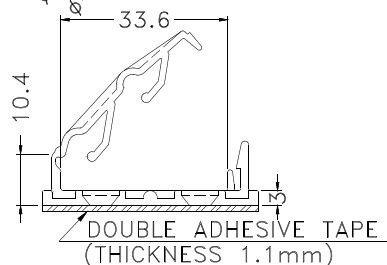
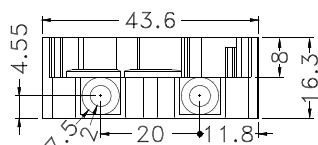

PART NO	PACKAGE
FCL-33	100

# FLAT CABLE MOUNT / CLAMP

Hankook Fastener

- ◆ MATERIAL: NYLON 66(UL)
- ◆ FLAME CLASS :94V-2
- ◆ COLOR:NATURAL
- ◆ UNIT:mm

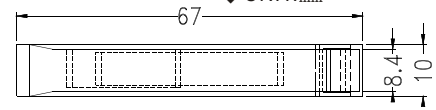
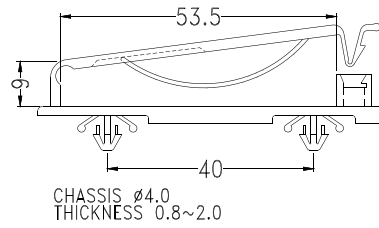

PART NO	PACKAGE
FDT-4	100

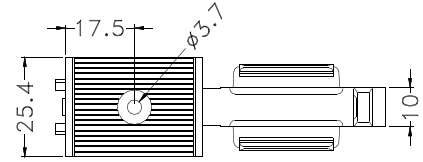
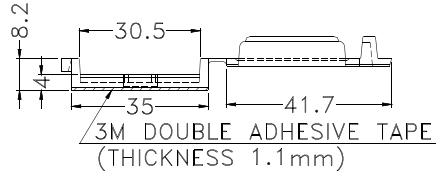

PART NO	PACKAGE
FCH-30	100

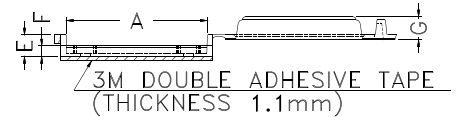
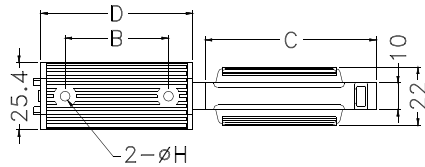

PART NO.	A	B	C	D	E	F	G	H	PACKAGE
FCH-50	53.0	39.0	64.6	57.3	8.3	4.1	8.8	3.7	50
FCH-80	78.93	38.7	90.6	82.3	12.3	6.3	7.6	3.8	50

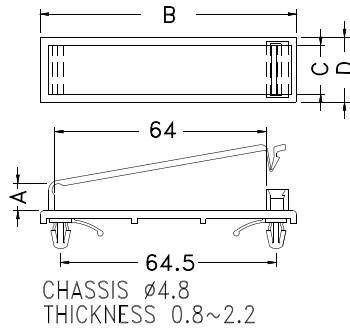
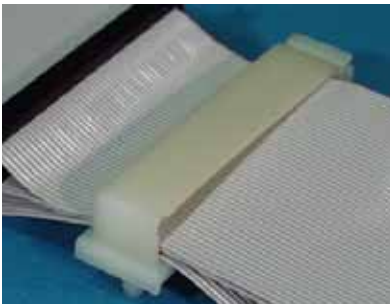

PART NO	A	B	C	D	PACKAGE
FCT-1	7.8	77.4	14.8	19.6	50
★ FCT-1L	12.9	77.0	14.6	20.0	50

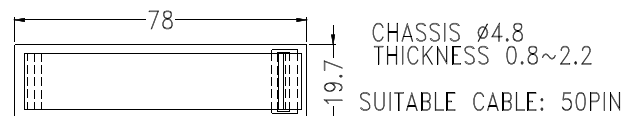
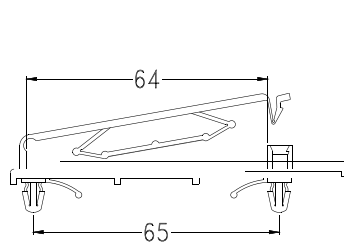
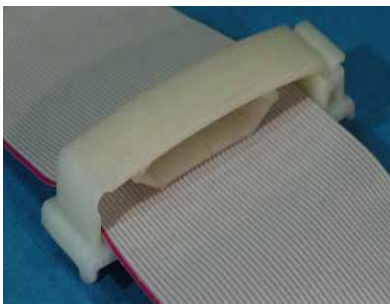

PART NO	PACKAGE
FCD-1	50

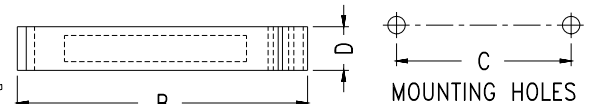
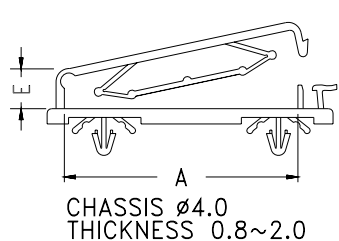

PART NO	A	B	C	D	E	SUITABLE CABLE	PACKAGE
FCD-40	53.8	65.0	40.0	10.2	9.0	40 PIN	100
FCD-50	64.3	77.0	49.7	10.0	12.7	50 PIN	

# FLAT CABLE MOUNT / CLAMP

Hankook Fastener

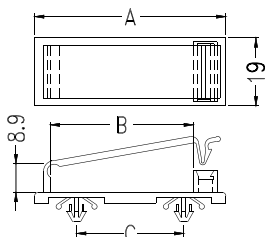

CHASSIS  $\phi 4$   
THICKNESS 0.8~2.2

- ◆ MATERIAL: NYLON 66(UL)
- ◆ FLAME CLASS :94V-2
- ◆ COLOR: NATURAL
- ◆ UNIT: mm

PART NO	A	B	C	PACKAGE
FCT-2	53.5	40.0	30.0	50
FCT-3	45.5	32.0	25.0	

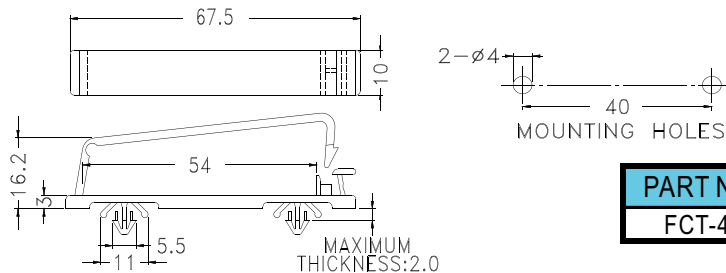

MAXIMUM THICKNESS: 2.0

PART NO	PACKAGE
FCT-4	100

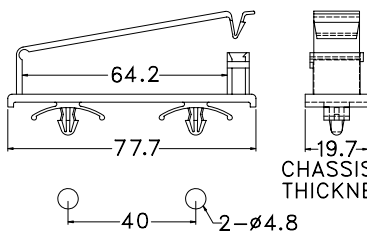

CHASSIS  $\phi 4.8$   
THICKNESS 0.8~3.2

PART NO	PACKAGE
FCT-5	50

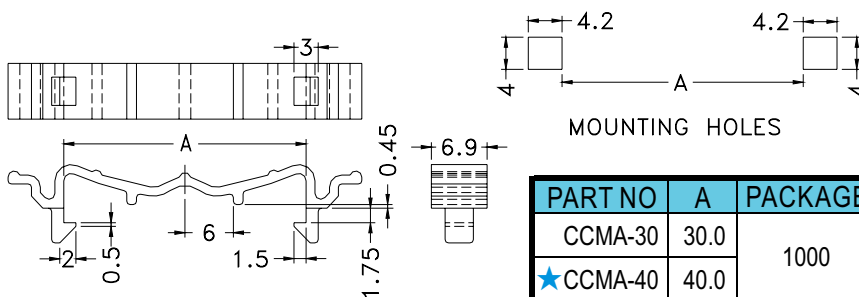
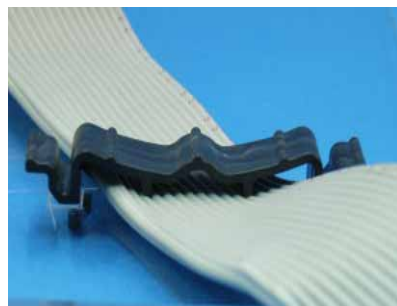

MOUNTING HOLES

PART NO	A	PACKAGE
CCMA-30	30.0	1000
★CCMA-40	40.0	

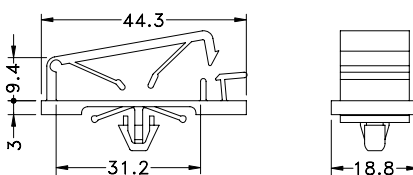

CHASSIS  $\phi 6.5$   
MAX. THICKNESS 2.2

PART NO	PACKAGE
FCJ-30	100

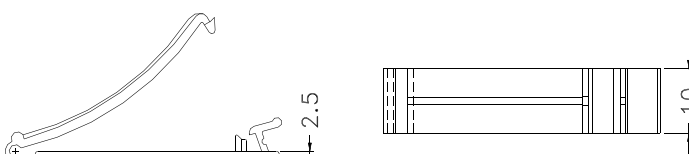
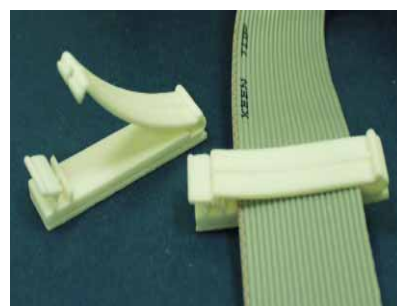

3M DOUBLE ADHESIVE TAPE  
(THICKNESS 1.1mm)

PART NO	PACKAGE
FCJ-40	100